

A**LOKSA****S455-POL/143**

A	B	C	D
1	S455-3001	1370	220
2	S455-4001	1430	165

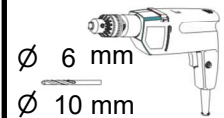
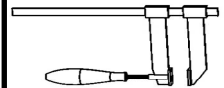
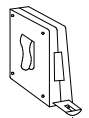
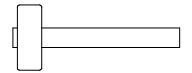
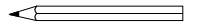
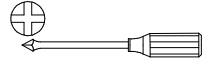
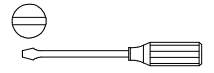
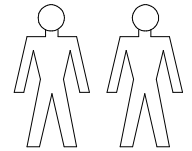

Ø 6 mm

Ø 10 mm

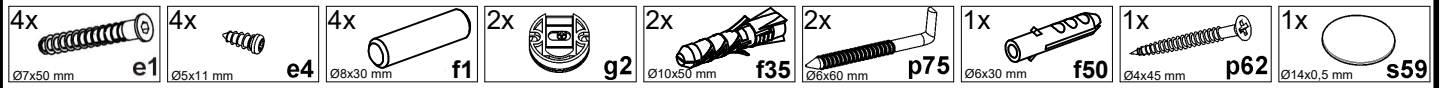
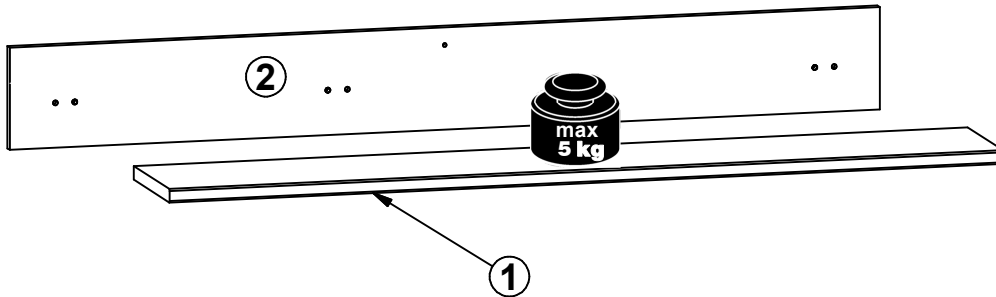
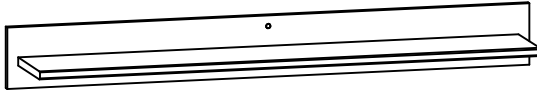

1 §2

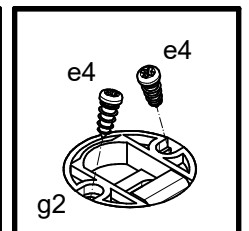
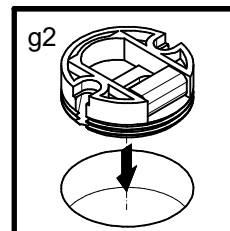
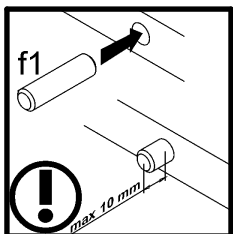
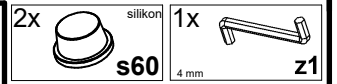
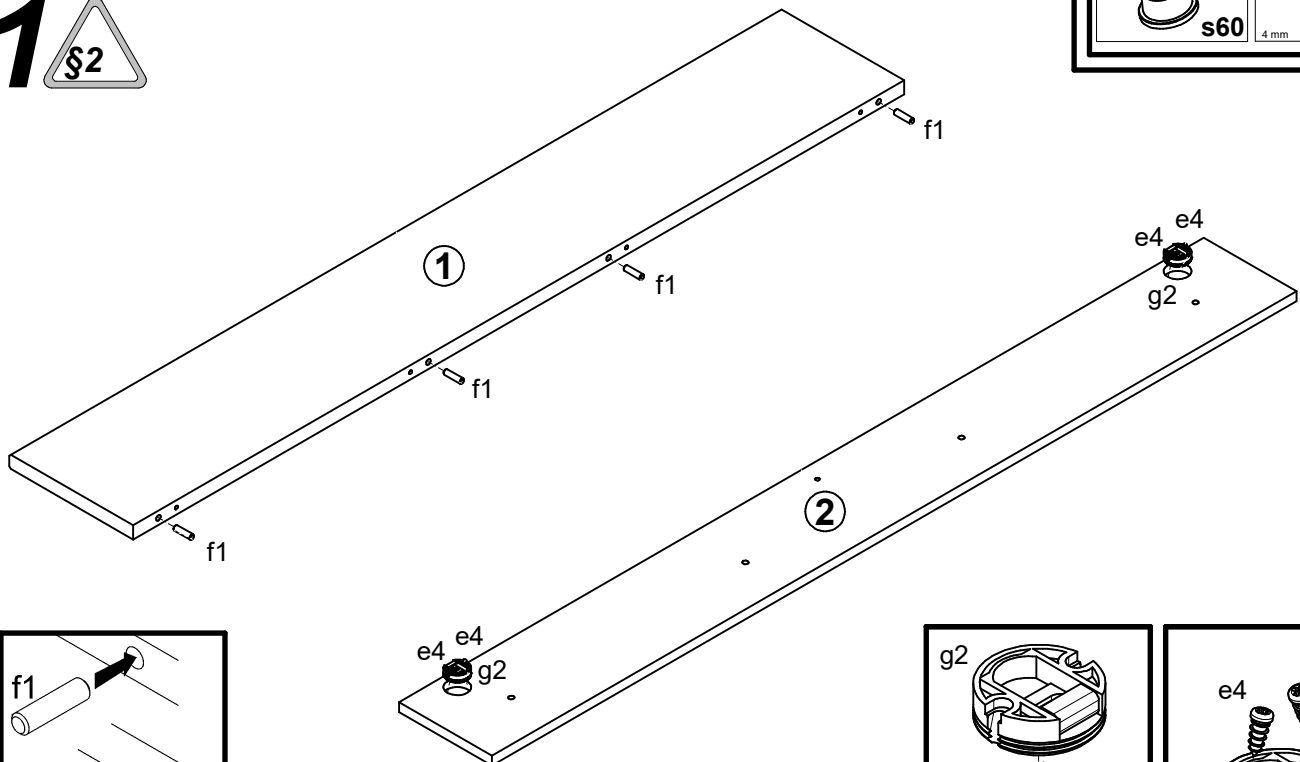

2 §6

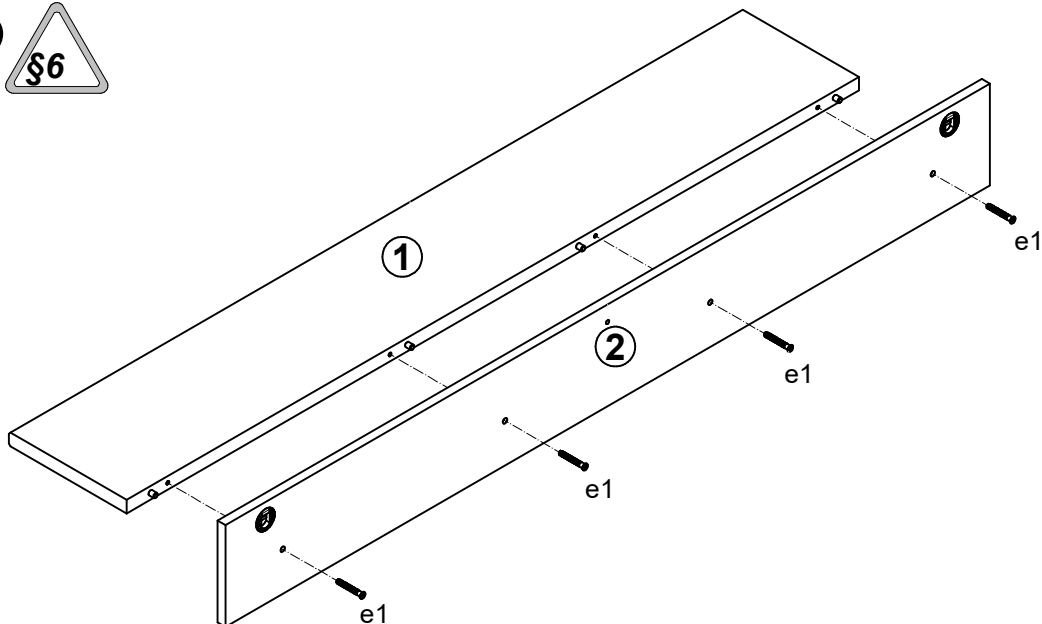

3 §6



φ10 mm

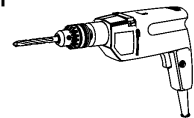

f35

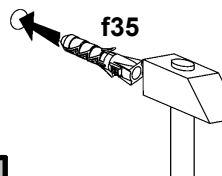

f35

p75

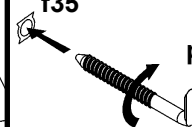

1cm

p75

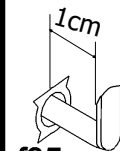

f35

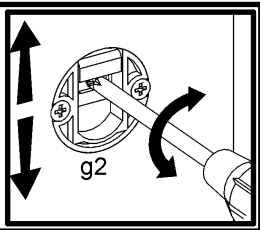

g2

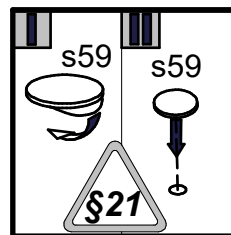
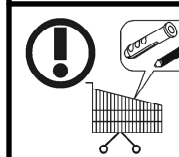
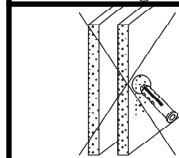
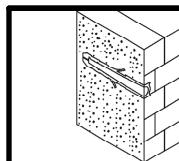
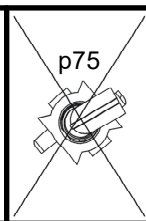
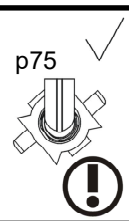
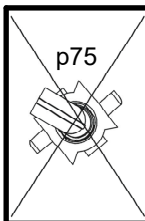

f35 p75

s60

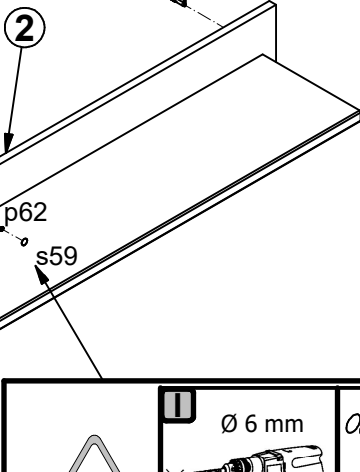

Ø 6 mm

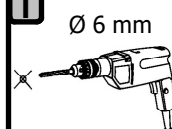

f50

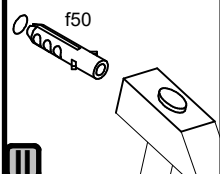

p62

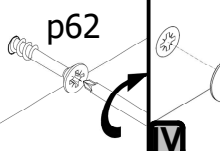

s59

