

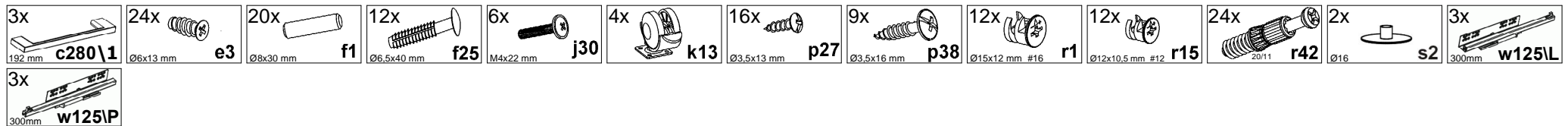

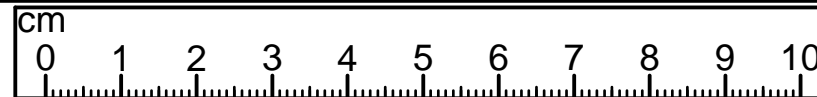

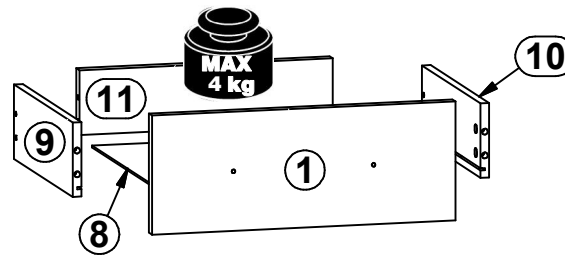

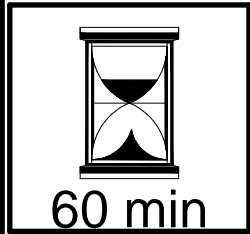
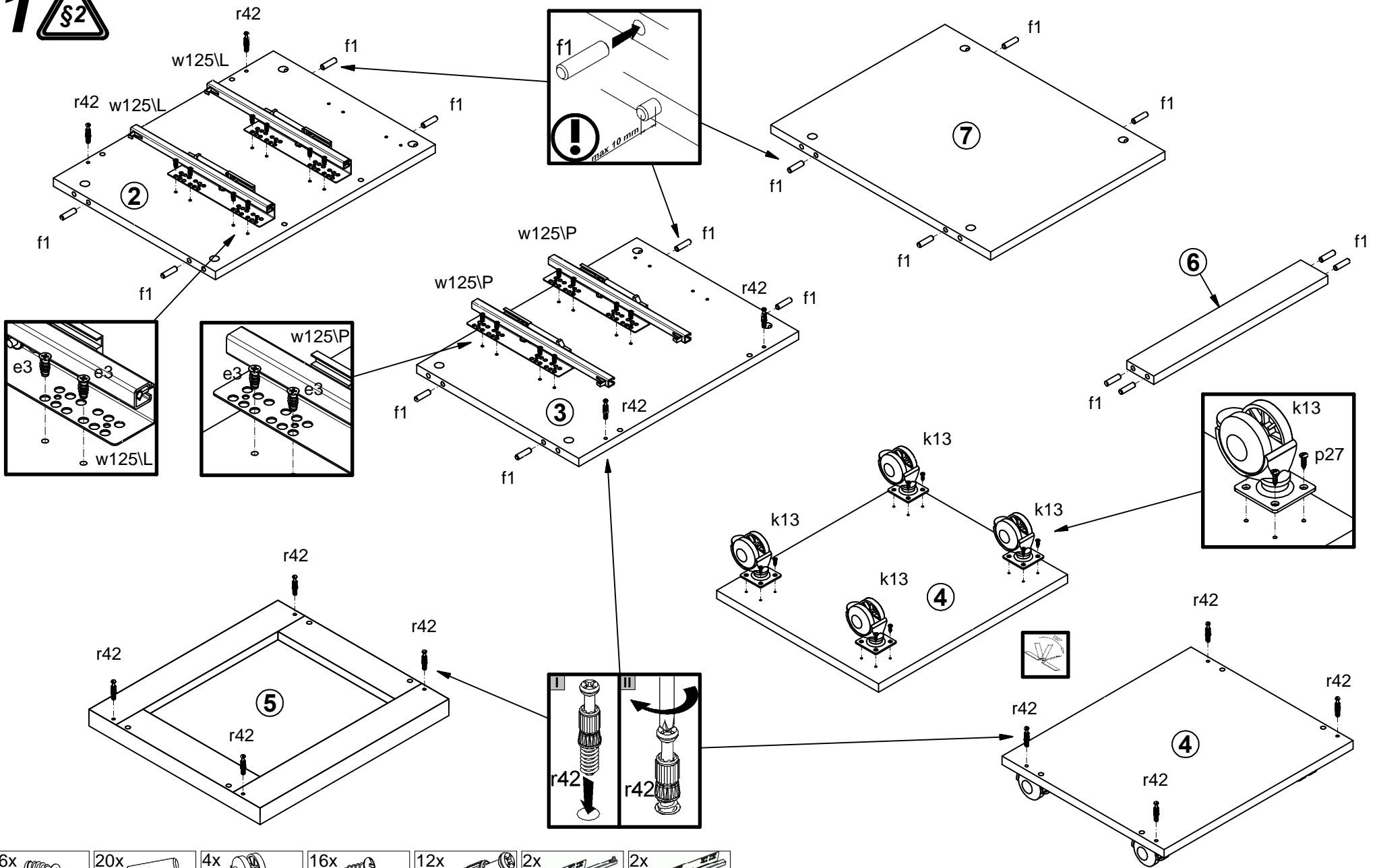

A	B	C (mm)		D
1	S228-018	416	160	1/1
2	S228-132	489	360	1/1
3	S228-133	489	360	1/1
4	S228-212	420	360	1/1
5	S228-213	420	380	1/1
6	S228-411	387	60	1/1
7	S228-412	489	387	1/1
8	WSP-978	357	308	1/1
9	WSQ2-503	300	100	1/1
10	WSQ2-504	300	100	1/1
11	WTQ-5128	347	87	1/1







- 16x  e3  
Ø6x13 mm
- 20x  f1  
Ø8x30 mm
- 4x  k13
- 16x  p27  
Ø3,5x13 mm
- 12x  r42  
20/11
- 2x  w125\L  
300mm
- 2x  w125\P  
300mm

**2** 

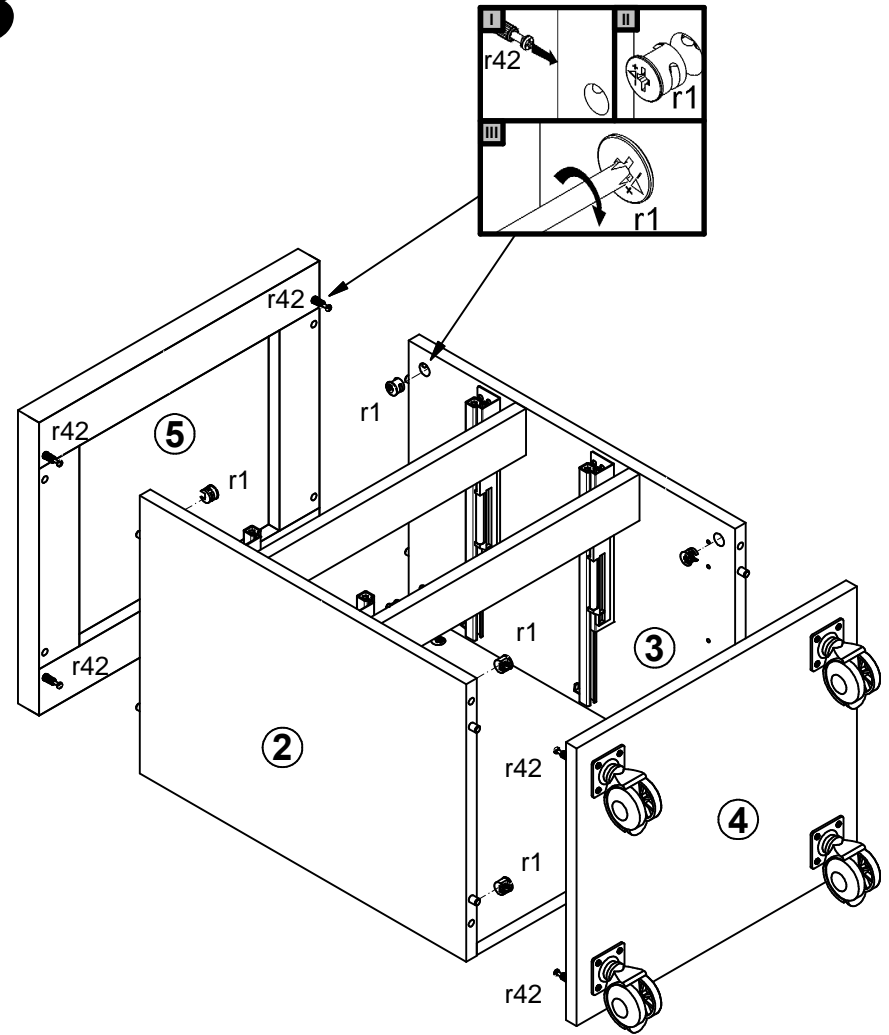
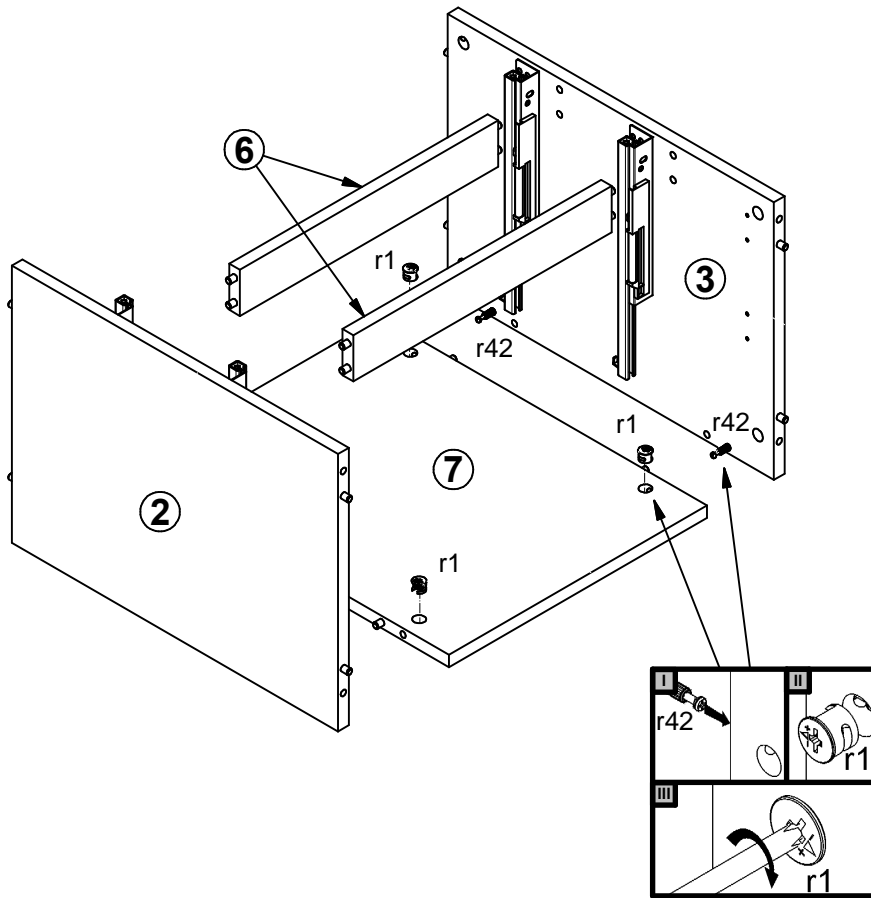
**3**



4x  r1  
Ø15x12 mm #16

8x  r1  
Ø15x12 mm #16

4

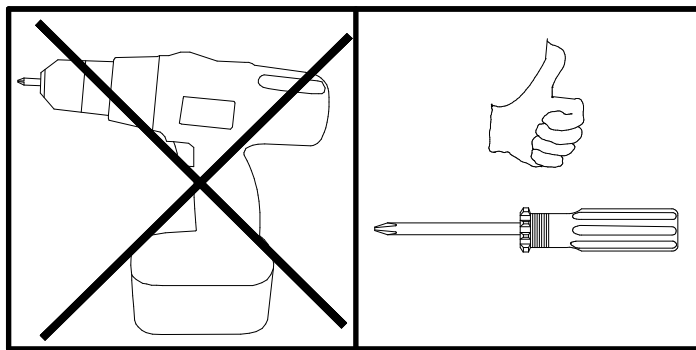
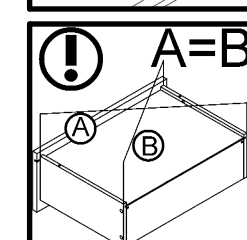
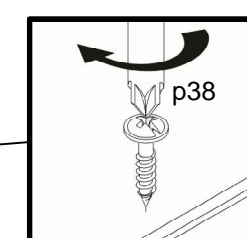
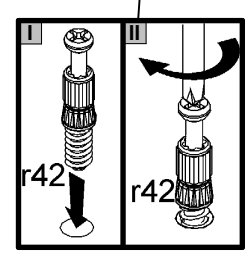
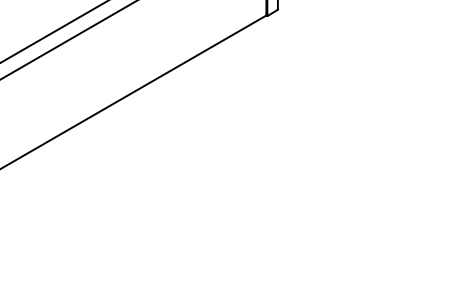
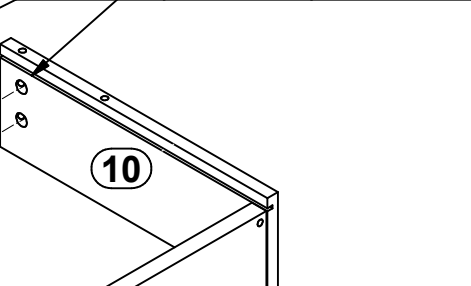
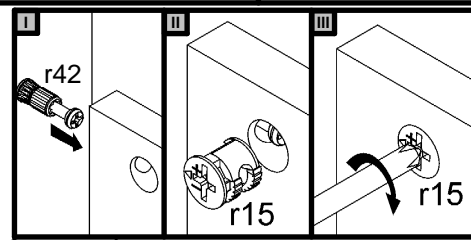
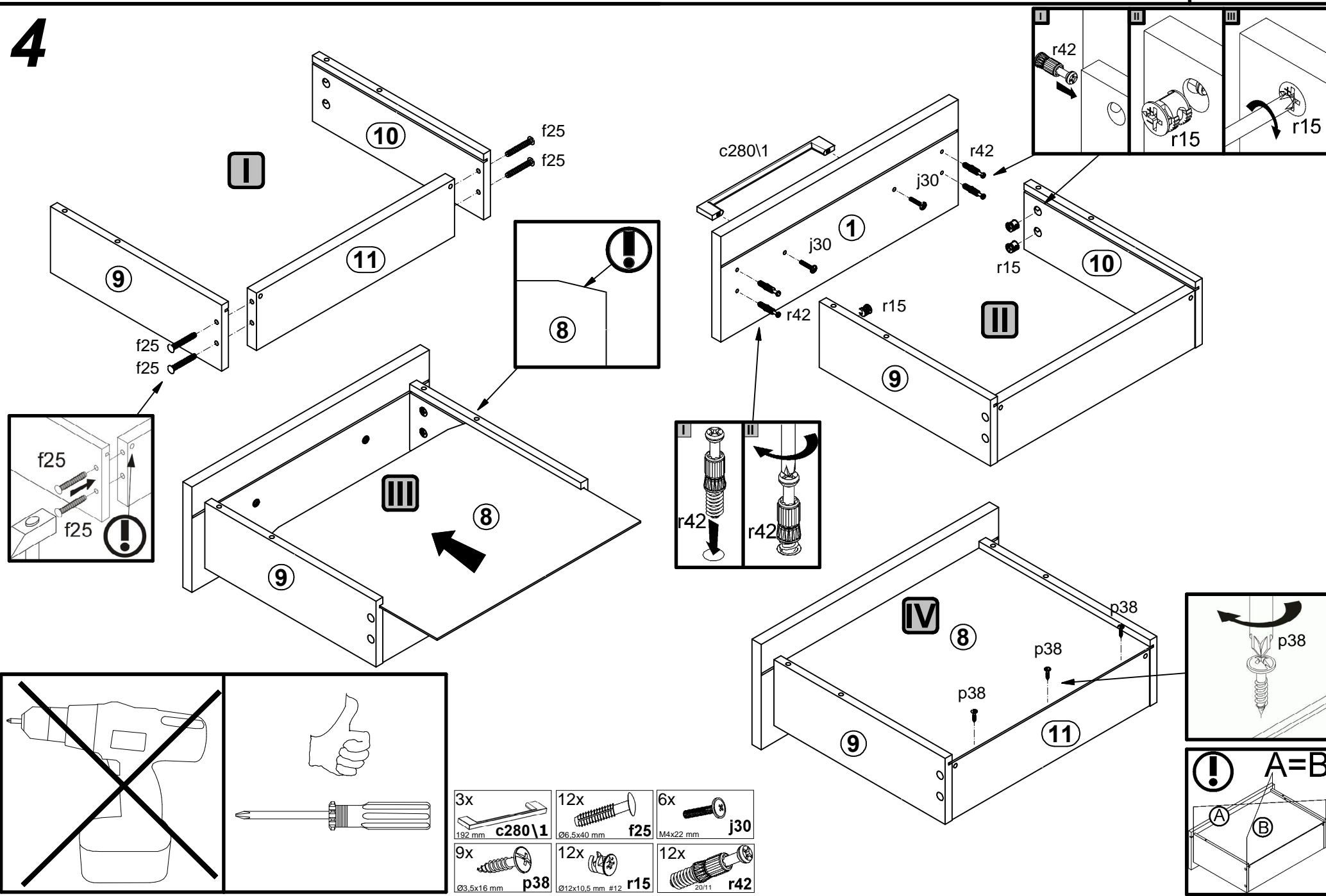

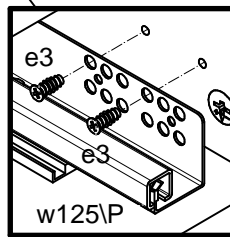
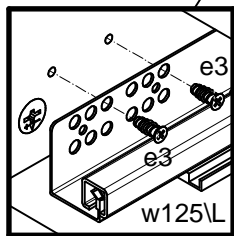
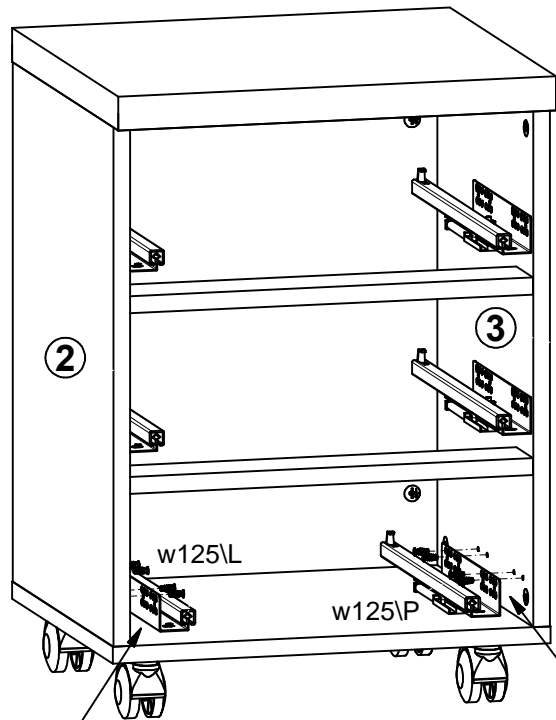

3x 192 mm <b>c280\1</b>	12x Ø6.5x40 mm <b>f25</b>	6x M4x22 mm <b>j30</b>
9x Ø3.5x16 mm <b>p38</b>	12x Ø12x10.5 mm #12 <b>r15</b>	12x 20/11 <b>r42</b>

5

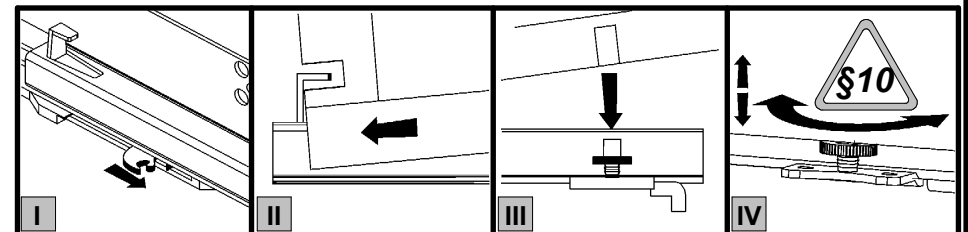
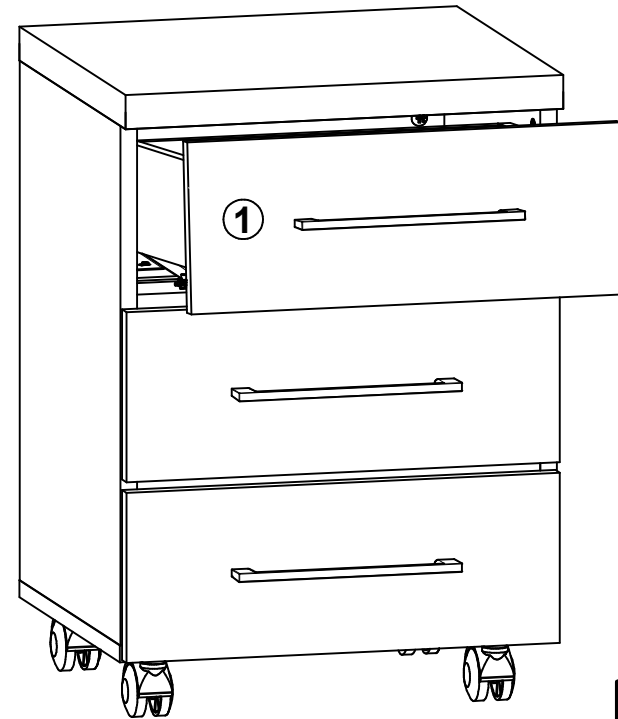

6



- 8x  e3 Ø6x13 mm
- 1x  w125L 300mm
- 1x  w125P 300mm
- 2x  s2 Ø16