

A	B	C	D	A	B	C	D		
1	S325-023	1954	496	3/3	9	S325-323	320	300	2/3
2	S325-025	1954	296	3/3	10	S325-324	319,	300	2/3
3	S325-126	2032	370	1/3	11	S325-425	1956	302	1/3
4	S325-127	2032	370	1/3	12	S325-426	798	60	2/3
5	S325-130	1956	302	1/3	13	S325-920	1982	657	3/3
6	S325-131	1956	302	1/3	14	S325-921	1982	943	3/3
7	S325-210	948,5	948,5	2/3	15	dr-576	576	22	2/3
8	S325-322	932,	932,	2/3					

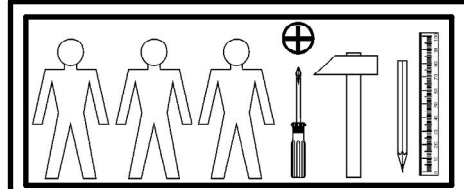

6x a32	6x b31	1x c417 64 mm	24x d1 Ø5x17 mm	18x e1 Ø7x50 mm	1x e11 Ø7x40 mm	29x f1 Ø8x30 mm	2x j30 M4x22 mm	6x k1
1x k17/2 Ø60x66	140x l1	2x n1 h=22mm	1x n25 40x46x30/1,5	2x o21 silikon	2x p1 Ø3,5x13 mm	2x p27 Ø3,5x13 mm	9x p38 Ø3,5x16 mm	12x p51 Ø3,5x15 mm
12x r1 Ø15x12 mm #16	12x r42 20/11	6x s1	4x s2 Ø16	1x z1				

1 §2

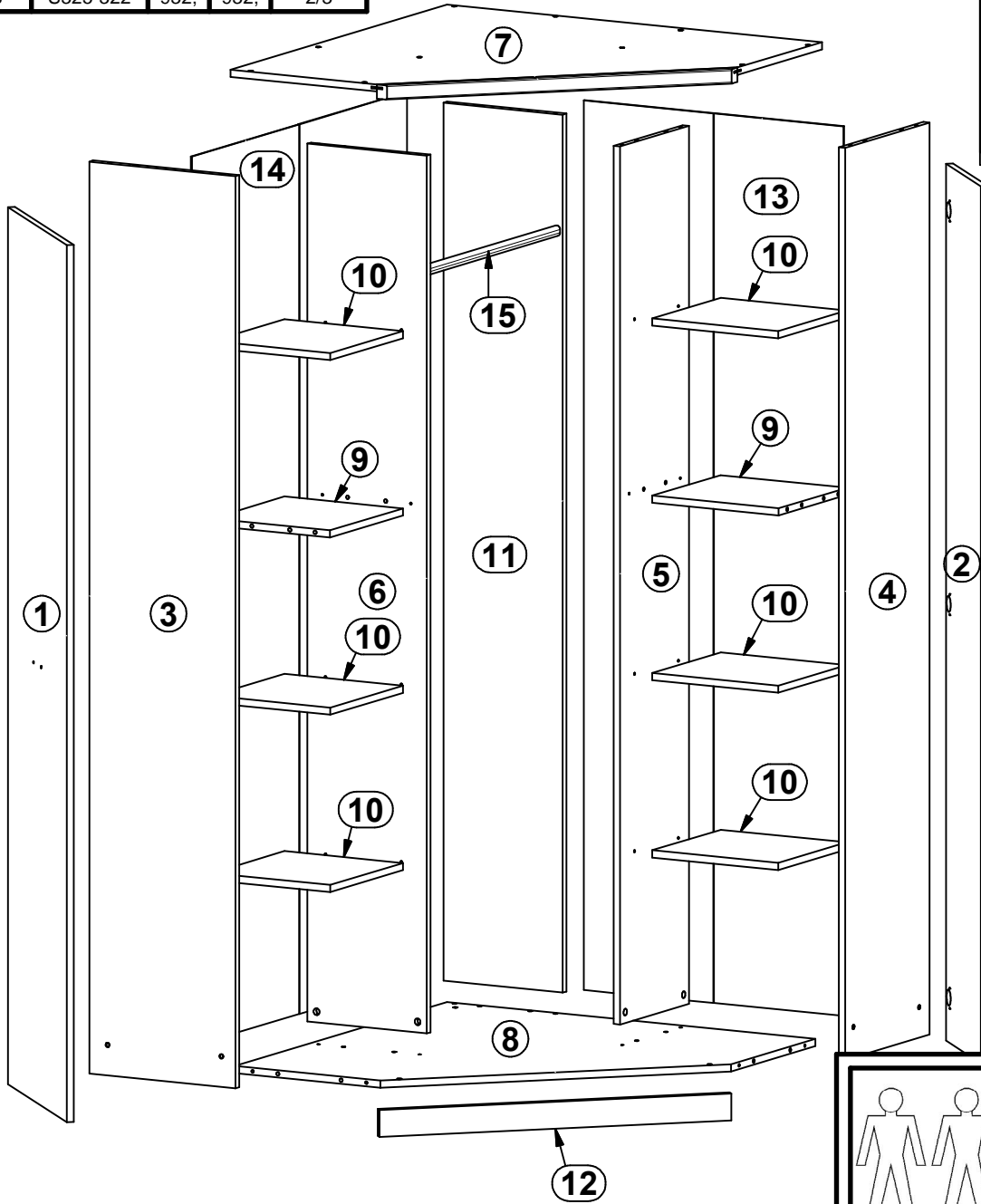
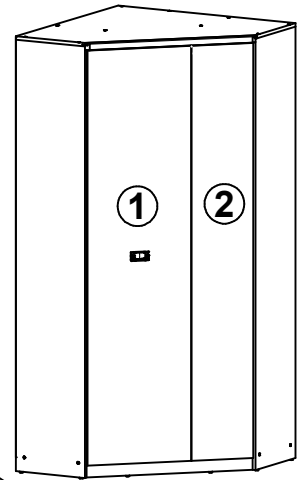
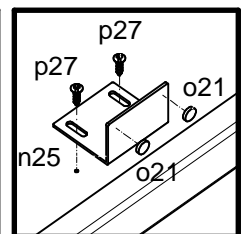
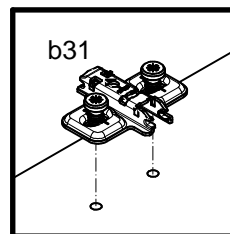
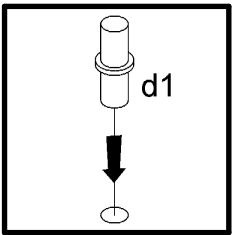
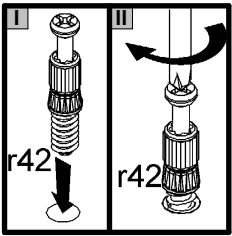
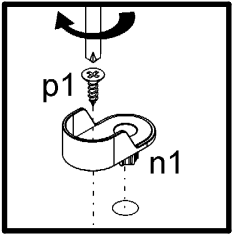
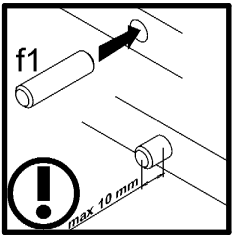
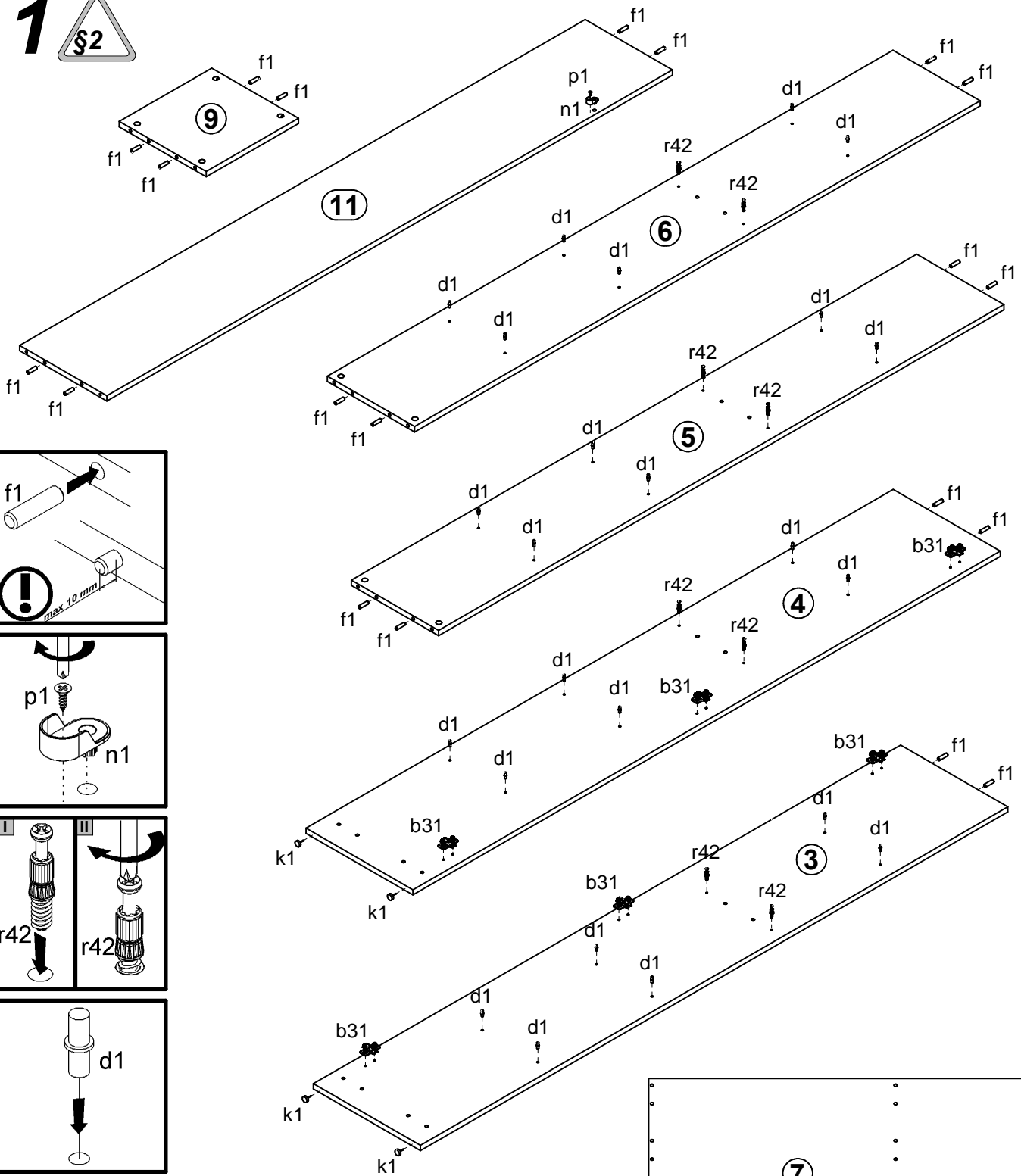

2

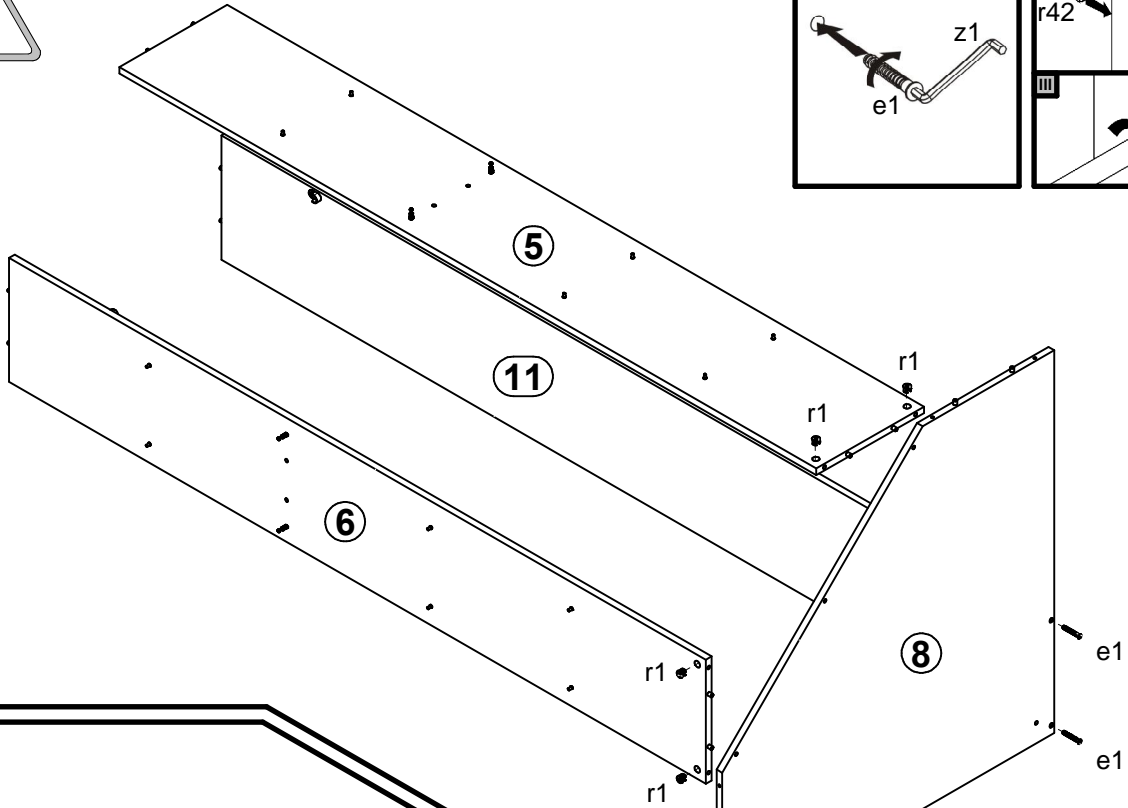

3

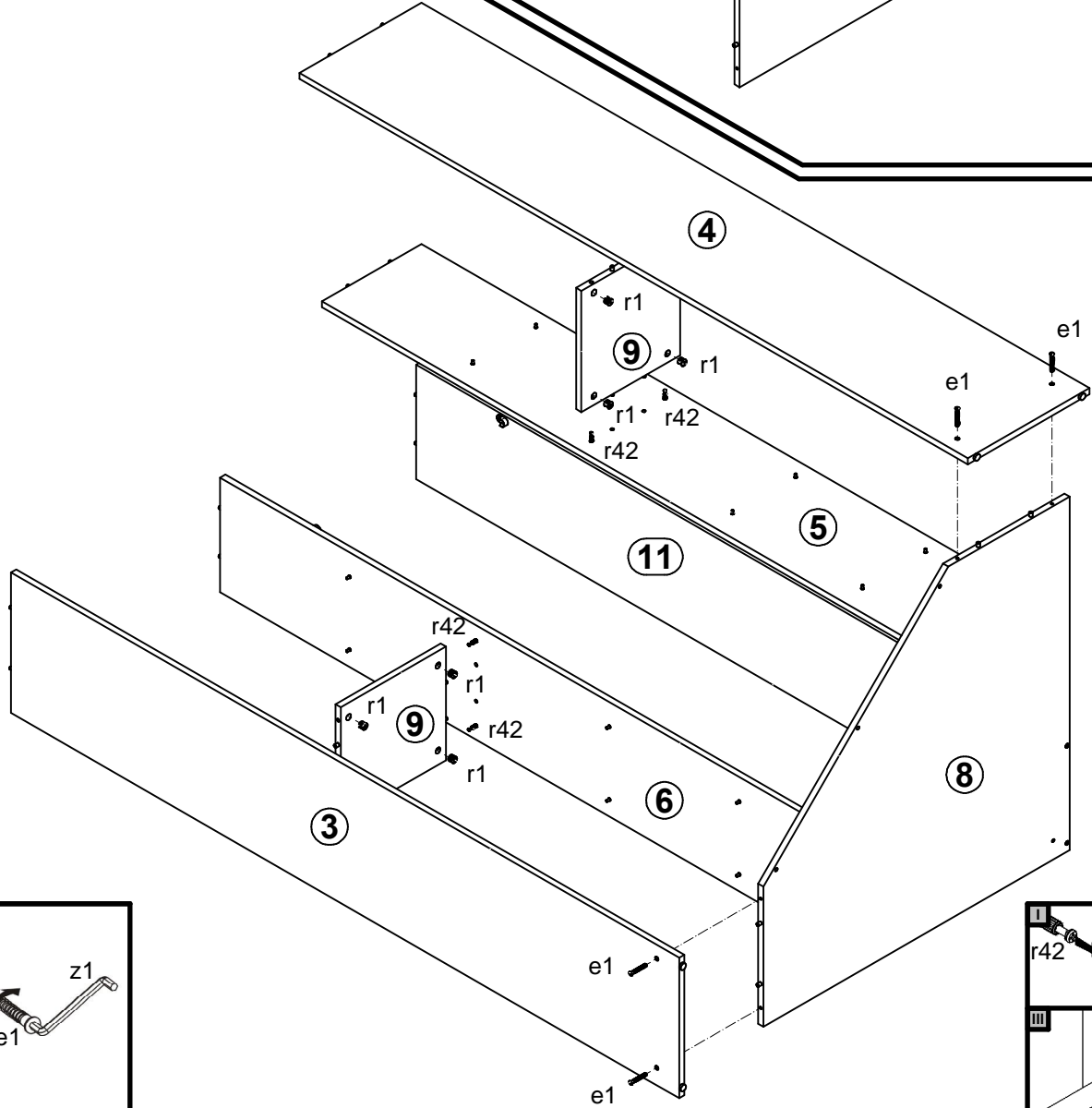

4

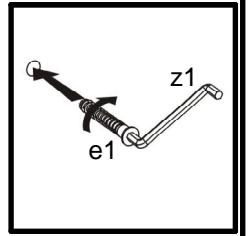
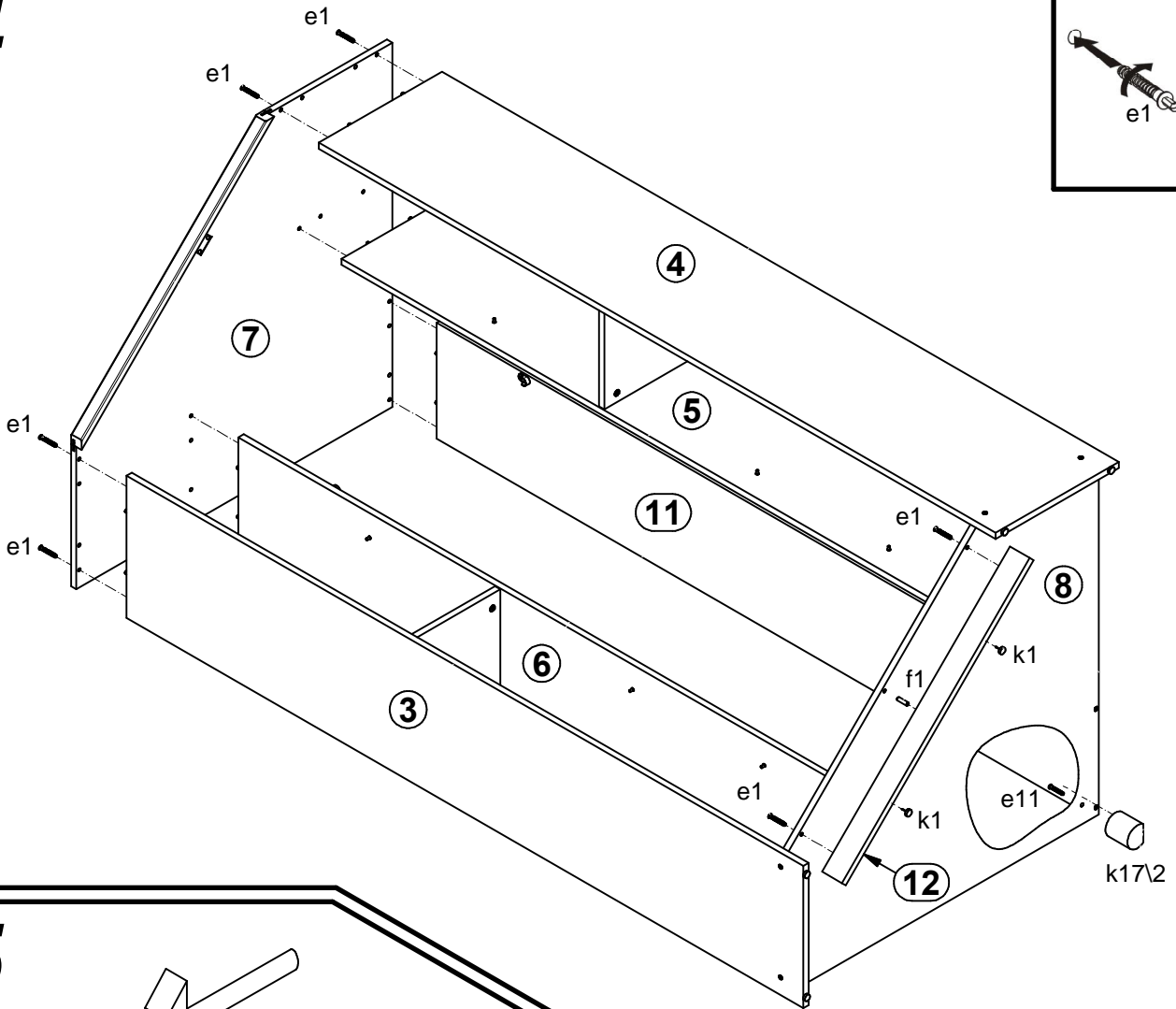

5

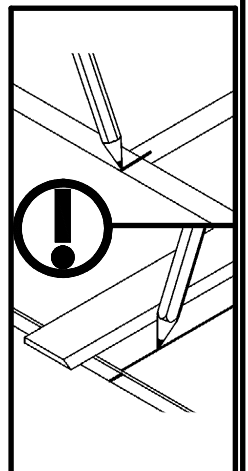
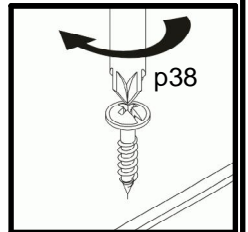
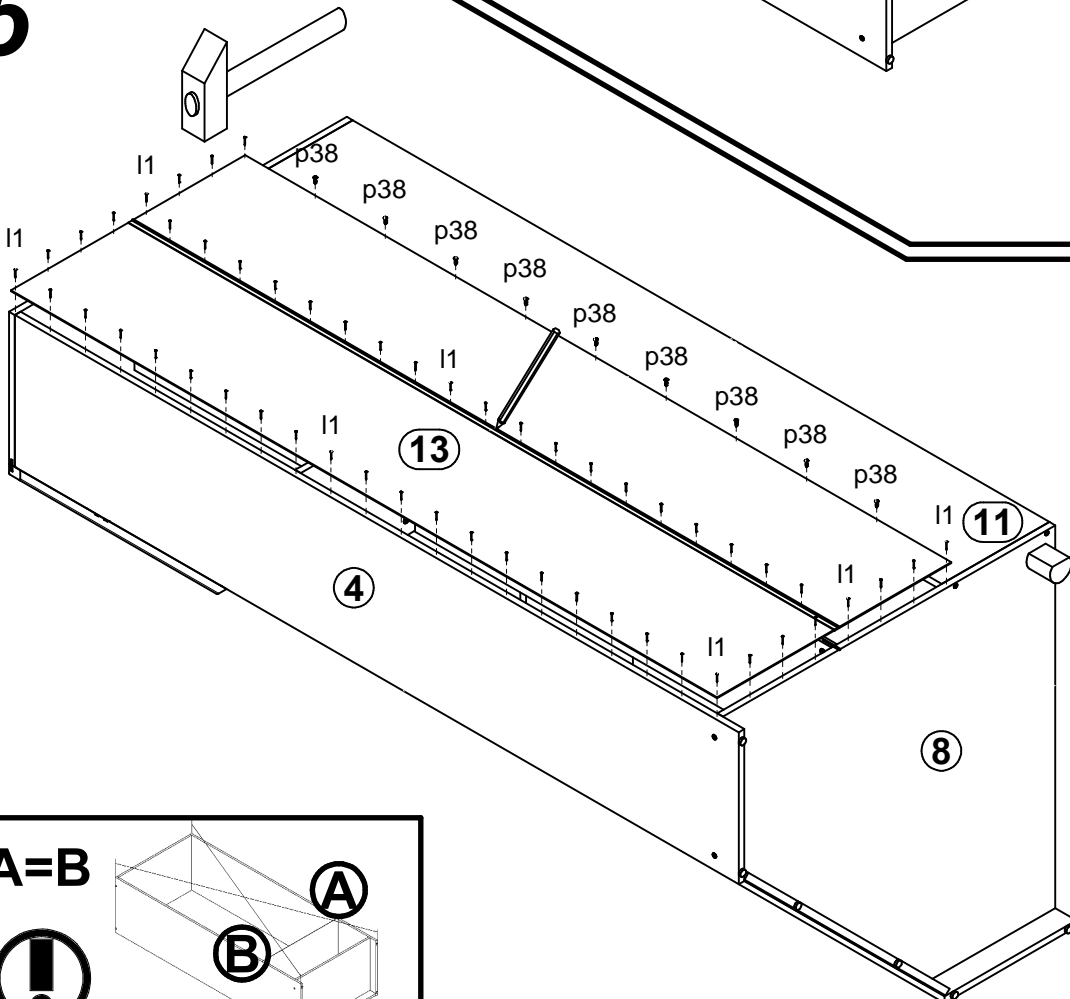

A=B

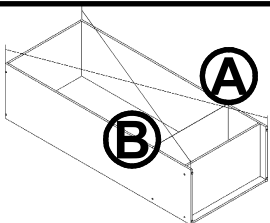

6

A=B

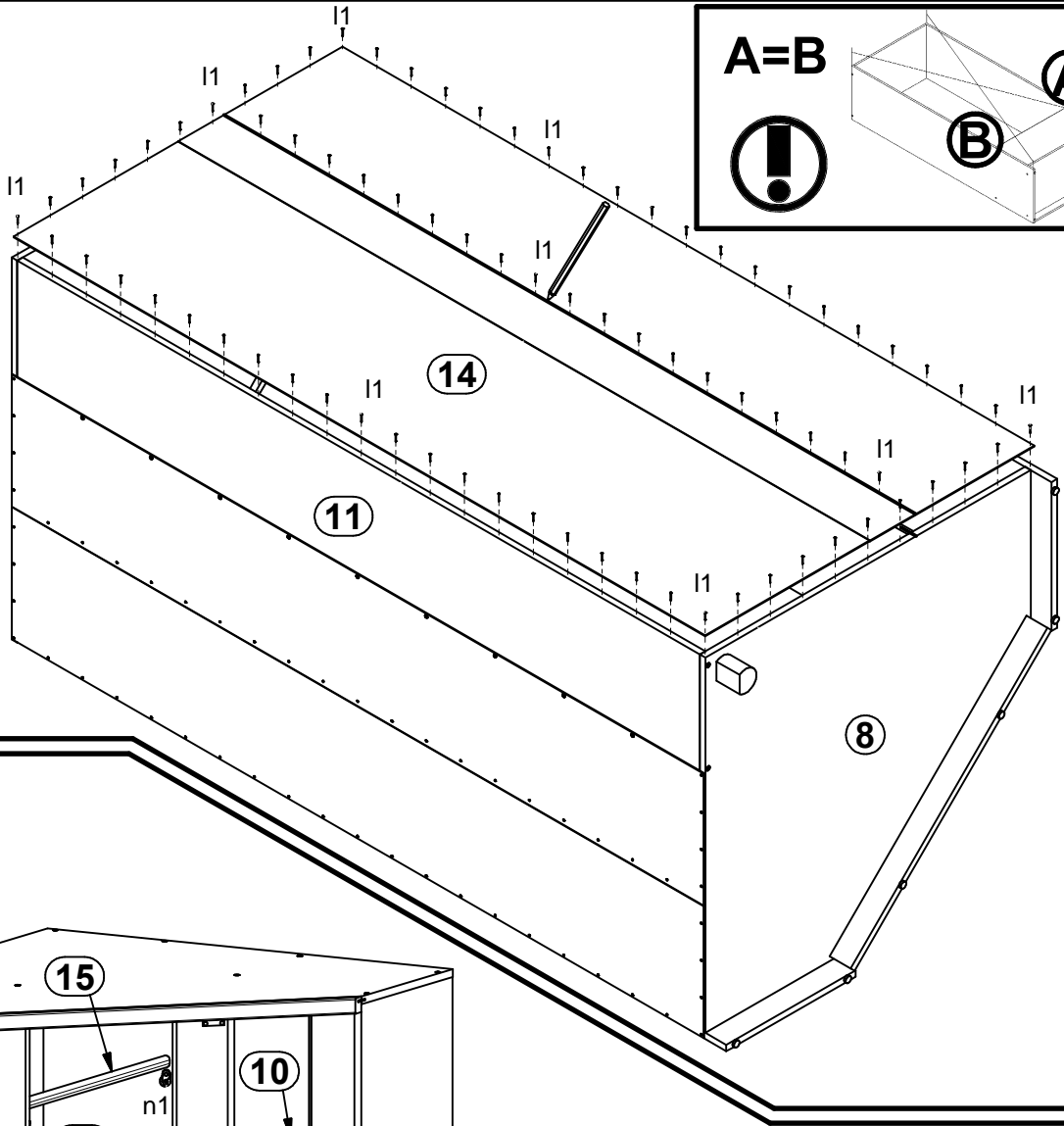
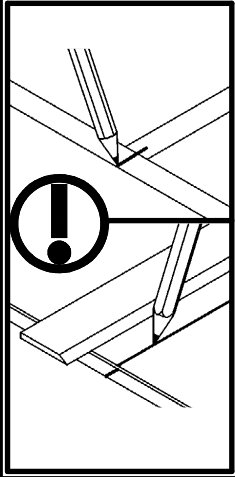
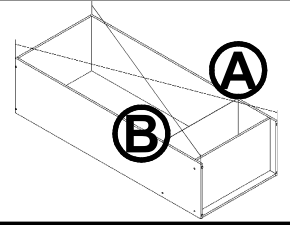

7

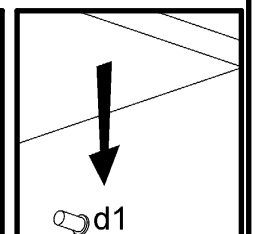
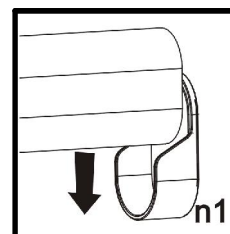
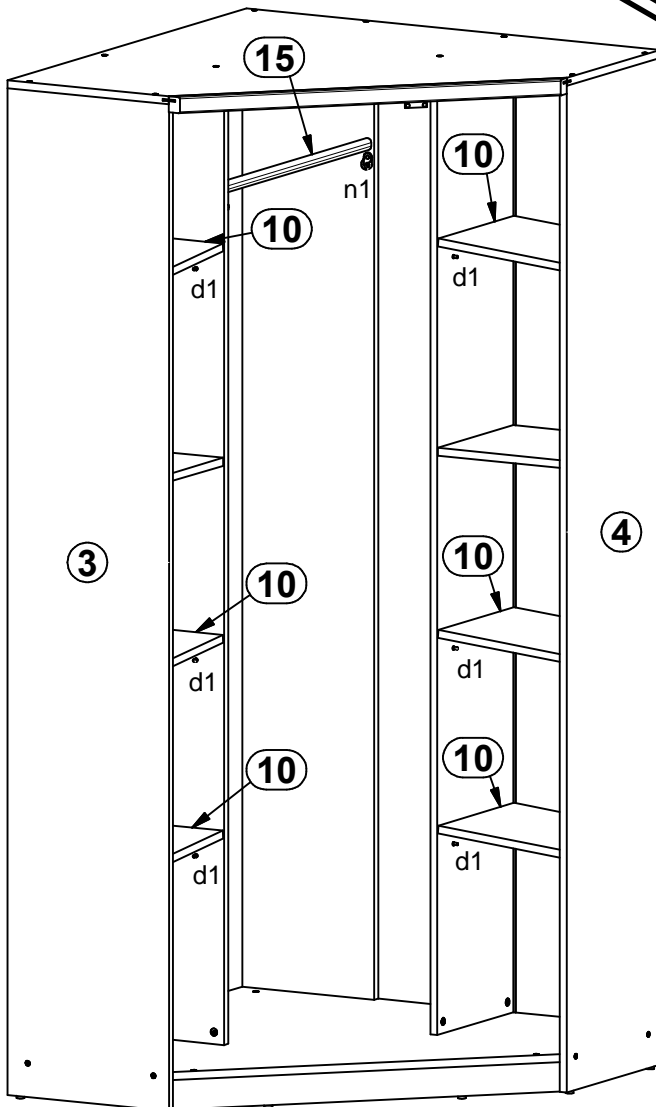

8

